

ATTENTION
TO FULLY BENEFIT FROM
THIS FIVE TUBE CHANGER
CONLUX RECOMMENDS:

COMPLETELY FILL
ALL FIVE TUBES OR AT LEAST
FILL THE PRIMARY TUBES!

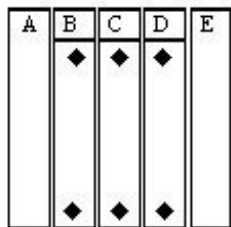

◆ Indicates primary tubes

25¢ 5¢ 25¢ 10¢ 25¢
 US-1 CASSETTE (3Q,1D,1N)
 Part Number 5030004030

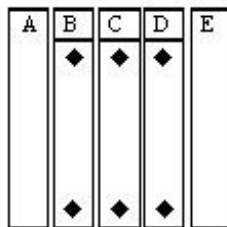

10¢ 5¢ 25¢ 10¢ 5¢
 US-2 CASSETTE (1Q, 2D, 2N)
 Part Number 5030004040

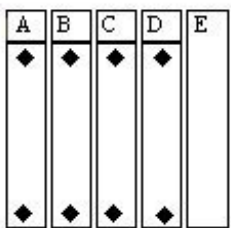

\$1 5¢ 25¢ 10¢ 25¢
 US-4 CASSETTE (1\$, 2Q, 1D, 1N)
 Part Number 5030004050

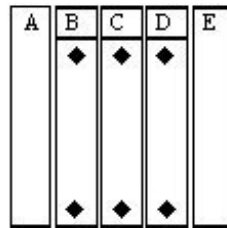

10¢ 10¢ 5¢ 10¢ 5¢
 US-5 CASSETTE (3D, 2N)
 Part Number 5030004060

WHEN CALLING FOR SERVICE, PLEASE PROVIDE THE FOLLOWING INFORMATION:

MODEL NUMBER: _____

SERIAL NUMBER: _____

Vendnet
 A WITTERN GROUP COMPANY
 165 NORTH 10TH STREET
 WAUKEE, IA 50263
 Tel. 1-877-4CONLUX
 (426-6589)







CCM5, CCM5G Series

Multi Drop Bus 5 Tube Coin Changer

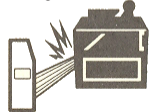
INSTALLATION GUIDE

Handling Instructions

<p>The discriminator is connected to the coin changer via a dedicated connector and should not be disassembled except for special cases such as cleaning.</p> 	<p>In case the discriminator is to be disassembled, be sure to turn off the power of the coin changer before disassembling.</p> 	<p>Do not carry the coin changer by the harness.</p> 	<p>Store the coin changer in a clean, dry place.</p> 
---	---	--	--

Identification of Parts and Locations

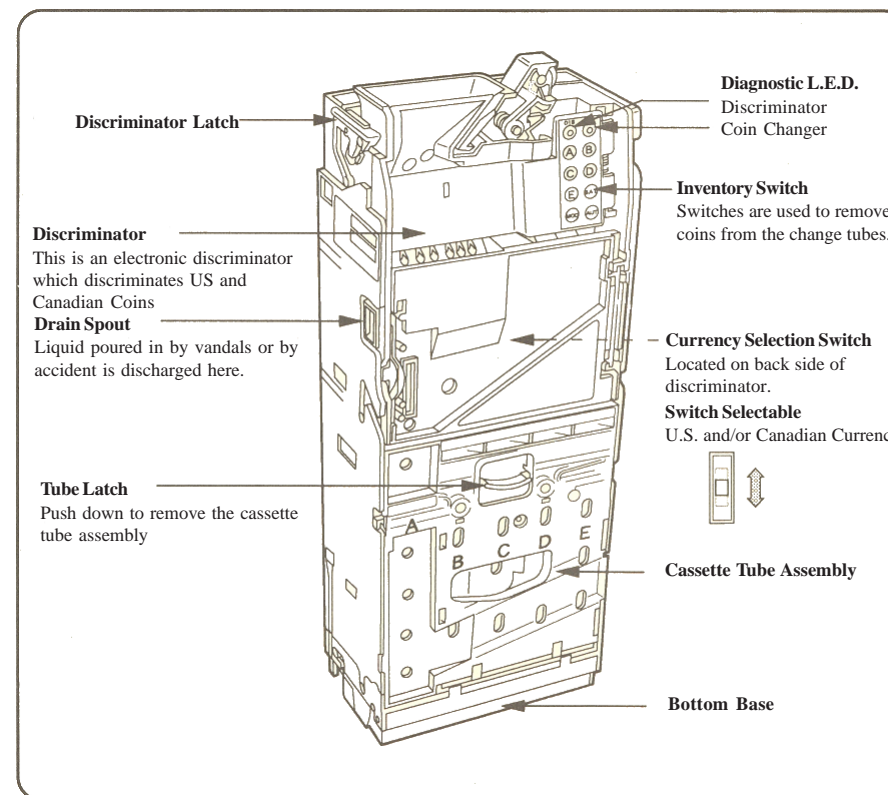

Limited Warranty Statement For Units Shipped After 12/01/06

Vendnet™, a Wittern Group Company, warrants all new Conlux coin changers and bill validators sold by it to be free from defective material and workmanship. Vendnet™ will repair or replace (at its option) any part of the coin changer or bill validator, which proves to be defective in materials or workmanship. The period of this limited warranty shall be twenty-four (24) months from the date of original sale by Vendnet™.

Other conditions applying to this limited warranty are as follows:

(A) This limited warranty does not apply to any coin changer or bill validator that only requires normal and customary cleaning to obtain serviceability.

(B) This limited warranty does not apply to any coin changer or bill validator, which has been, in Vendnet™ opinion, subject to: vandalism, accident, abuse, misuse, neglect, improper installation, missing parts, improper maintenance, repair by unauthorized service personnel; or is found to include parts other than genuine Vendnet™ /Conlux supplied parts or options.





(C) Vendnet™ will not be responsible for any expense incurred by the purchaser incidental to the repair or replacement of equipment covered by this warranty.

(D) THIS LIMITED WARRANTY IS IN LIEU OF ALL OTHER WARRANTIES ORAL OR WRITTEN, EXPRESSED OR IMPLIED, INCLUDING WITHOUT LIMITATION, WARRANTIES OF MERCHANTABILITY, WARRANTIES OF FITNESS OF PURPOSE, AND ALL OTHER OBLIGATIONS OR LIABILITIES OF VENDNET™/CONLUX. VENDNET™ NOR CONLUX ASSUMES NOR AUTHORIZES ANY PERSON TO ASSUME FOR IT, ANY OTHER OBLIGATION OR LIABILITY IN CONNECTION WITH THIS WARRANTY POLICY.

(E) LIABILITY TO VENDNET™ AND ITS APPOINTED FACTORY AUTHORIZED SERVICE CENTERS IS LIMITED TO THE REPAIR OR REPLACEMENT, AT THEIR OPTION, OF DEFECTIVE PARTS WITHIN THE CONLUX PRODUCT(S) AND DOES NOT INCLUDE INCIDENTAL AND CONSEQUENTIAL DAMAGES.

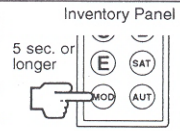
Coin Accept/Reject Programming Function

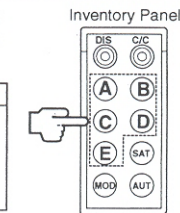

Coin Accept/Reject procedure

	Setting procedure	"DIS" lamp(red)												
STEP 1	<p>(1) Press the "MOD" display switch on the inventory panel for 5 seconds or until "DIS" lamp status flashing.</p> <p>(2) After 5 seconds, the "DIS" display monitor lamp (red) starts flashing rapidly to indicate that the Accept/Reject mode has been established (Programming mode).</p> 	<p>Rapid flashing after about 5 seconds</p> 												
STEP 2	<p>(1) Within 30 seconds, press the inventory switch corresponding to the type of coin to be specified for the Accept/Reject function.</p> <table border="1" style="margin-left: auto; margin-right: auto;"> <thead> <tr> <th colspan="2" style="text-align: center;">Inventory switches and corresponding coin types</th> </tr> </thead> <tbody> <tr> <td>A Inventory switch</td> <td>For setting 5¢ coin</td> </tr> <tr> <td>B Inventory switch</td> <td>For setting 10¢ coin</td> </tr> <tr> <td>C Inventory switch</td> <td>For setting 25¢ coin</td> </tr> <tr> <td>D Inventory switch</td> <td>For setting \$1 coin</td> </tr> <tr> <td>E Inventory switch</td> <td>For setting \$2 coin</td> </tr> </tbody> </table>  <p>(2) The type of coin specified by the inventory switch is set for the Accept/Reject function. Then, the "DIS" display monitor lamp (red) goes out for 1 second, then starts flashing rapidly again.</p> <p>For about 30 seconds the system remains in the Accept/Reject standby status.</p> <p><small>* If the currency selection switch (refer to Figure 5) is set to "U.S. only", \$2 coins cannot be specified for this function. Also, if "U.S. only" is selected while \$2 coin has been specified for the Accept/Reject function, the setting of \$2 this function is invalidated.</small></p>	Inventory switches and corresponding coin types		A Inventory switch	For setting 5¢ coin	B Inventory switch	For setting 10¢ coin	C Inventory switch	For setting 25¢ coin	D Inventory switch	For setting \$1 coin	E Inventory switch	For setting \$2 coin	<p>Goes out for 1 second</p>  <p>Flashes rapid again</p> 
Inventory switches and corresponding coin types														
A Inventory switch	For setting 5¢ coin													
B Inventory switch	For setting 10¢ coin													
C Inventory switch	For setting 25¢ coin													
D Inventory switch	For setting \$1 coin													
E Inventory switch	For setting \$2 coin													

Operating the return lever or pressing the "MOD" switch for 5 seconds or longer cancels the Accept/Reject mode and enters standby mode.

Notes: Other than the step above, the Accept/Reject mode ends under any of the following conditions:

- (1) No switch is pressed for more than 30 seconds since the Accept/Reject mode was established.
- (2) A coin or coins are inserted.
- (3) Abnormal condition occurs.
- (4) The main controller transmits a command to prohibit acceptance of all types of coins.

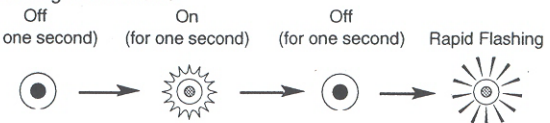
<p>• Check for the coin types specified for Accept/Reject function</p> <p>(1) The "DIS" display monitor lamp (red) flashes rapidly for 2 seconds upon turning on the power if any coin type has been specified for the accept/Reject function.</p>	<p>Rapid flashing for 2 seconds</p> 
<p>(2) The "DIS" display monitor lamp (red) goes out momentarily (for 0.25 second) when a coin type specified for the Accept/Reject function is inserted.</p>	<p>Goes out momentarily</p> 
<p>• Releasing the Accept/Reject programming</p> <p>You can reset the Accept/Reject setting for a coin type by repeating the same procedure for that setting (i.e., Steps 1 and 2 described above). During the reset operation, however, the DIS monitor LED (red) display will change differently from that indicated in the Step 2-(2) above. When the switch corresponding to the coin type to be reset is pressed, the DIS LED changes as follows.</p> <div style="text-align: center;"> <p>Off (for one second) On (for one second) Off (for one second) Rapid Flashing</p>  </div>	

- ◆ Insert at least 20 coins per tube for best performance.
- ◆ If a coin drops in and stands on end, correct it.
- ◆ Be careful not to load bent coins.
- ◆ Be certain to load the correct coin in each tube.
- ◆ After loading tubes manually, payout at least one coin from each tube to assure proper operation! Use inventory buttons A-E for payout.

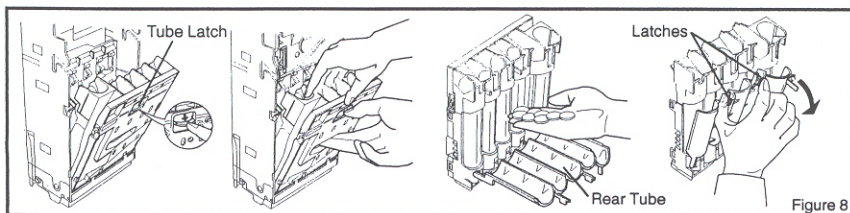
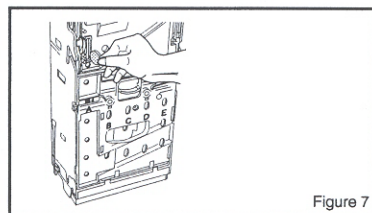
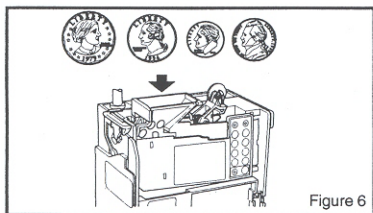
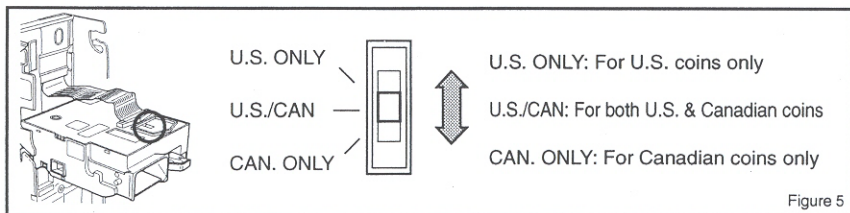
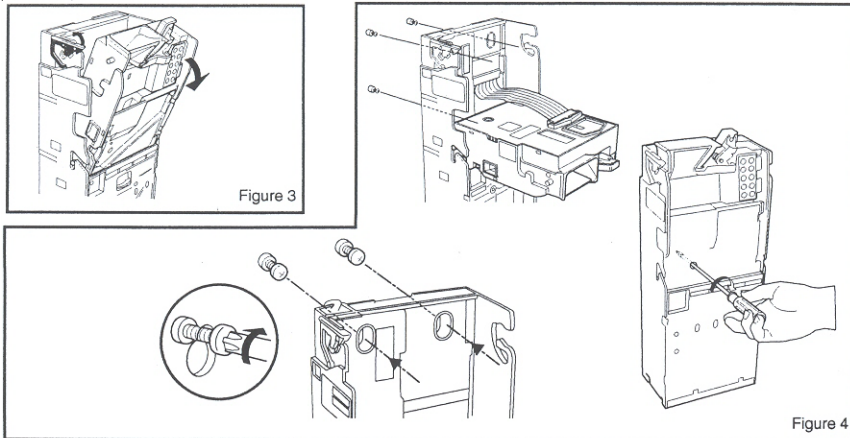

OPERATING THE AUTOMATIC CHANGE ADJUSTING FUNCTION (FLOAT)

This function allows the coin changer to return the tube levels to a controlled level.

1. Set the base quantities (the number of coins to be loaded initially).
2. Reinstall the cassette tube assembly into the changer.
3. Mark each tube with the base quantity (to make it easier to recognize a shortfall). The coin changer judges each set quantity as zero regardless of the actual count.
4. By pressing the "AUT" for a least one second the coin changer will return the tube levels to the base start level.
5. When the coins in the cassette become fewer than the base quantity, replenish the shortfall. If the coin amount in all tubes are less than preset level and the "AUT" switch is pressed, this becomes the new preset level.

The coin changer's memory will be affected when:

1. The cassette assembly is removed.
2. The coins are inserted directly into the tubes (manually).
3. Communication with the vending machine controller is interrupted.

DIAGNOSTIC AND CONTROL FUNCTIONS

1. Two L.E.D.'s are provided to indicate a coin changer or discriminator malfunction. (Please see Figure 1) If a failure is detected, the appropriate L.E.D. will blink. In the normal operating state both L.E.D.'s are on!

L.E.D. "DIS" (Red) indicates a discriminator malfunction.
L.E.D. "C/C" (Yellow) indicates a coin changer malfunction.

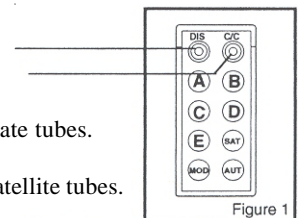

2. Switches A-E are used to inventory coins from the appropriate tubes.
3. Switch "SAT" is used to inventory coins from the optional satellite tubes.
4. Switch "MOD" is used to Accept/Inhibit a certain coin. Please contact the factory, if you would like to utilize this feature.
5. Switch "AUT" is used when operating the Automatic Change Adjusting Function (Float).
6. Switch "AUT" is also used to Delete Memory Backup:
 1. Remove the cassette assembly from the coin changer.
 2. Press and hold down the "AUT" button for about 5 seconds.
 3. The two L.E.D.'s will flash rapidly for about 1 second indicating the memory has been cleared.
 4. Reinstall the cassette.

PREVENTATIVE MAINTENANCE

The leading causes for coin changers malfunctions are:

1. Dirty coin path, which slows coin speed down.
2. Defective (bent) coins.
3. Salt water damage.

Periodically clean all shaded surfaces with a damp cloth using a mild detergent. DO NOT USE SOLVENTS OR OTHER INDUSTRIAL CLEANERS! (Please see Figure 2)

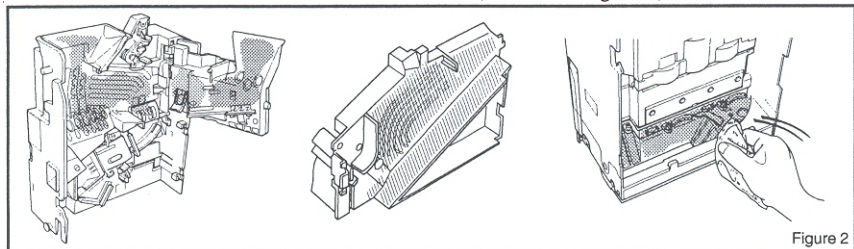

Figure 2

CCM5, CCM5G SERIES SPECIFICATIONS

Interface	Multi-Drop-Bus (M.D.B.)
Operating Voltage	34 Volt D.C.
Power Consumption	Standby 0.10A
Operating State	Motor Operation 0.66A Peak Max. 5 second 0.92A
Operation Temperature Range	5°F (-15°C) to 140°F (+60°C)
Insulation Resistance	20 Mega-Ohms or more
Weight	4.2lbs. (1.9 kg)
Dimensions	(H x W x D) 14.83" x 5.43" x 3.23" (376mm x 138mm x 82mm)
Number of Motors	1 Motor - 15 Volt D.C.
Number of Solenoids	5 for Coin Selection (15 Volt D.C.)
Coin Acceptance	5¢, 10¢, 25¢, \$1, and \$2 U.S. only, Canadian only or U.S. & Canadian

OPTIONAL CASSETTES AVAILABLE

1. US-1 Cassette - 3Q, 1D, 1N
2. US-2 Cassette - 1Q, 2D, 2N
3. US-4 Cassette - 1\$, 2Q, 1D, 1N
4. US-5 Cassette - 3D, 2N

Add on satellite tube (maximum two tubes any combination)

- A. Satellite Tube ST5 - 5¢ tube - 110 coins each
- B. Satellite Tube ST25 - 25¢ tube - 130 coins each

FEATURES

FEATURES OF THE CCM5, CCM5G-SERIES COIN CHANGER:

- FIVE TUBE CASSETTE
- AUTOMATIC CASSETTE SENSING FUNCTION (**NO PROGRAMMING NEEDED**) .
- SIMULTANEOUS PAYOUT OF UP TO 3 COINS (WITH LEVEL 3 CONTROLLER) .
- SALT WATER DRAINS
- AUTO RECOVERY FUNCTION (IN CASE OF MOTOR LOCK)
- MEMORY BACKUP FUNCTION (IN CASE OF POWER FAILURE)
- L.E.D. DIAGNOSTIC
- M.D.B. INTERFACE
- AUTOMATIC CHANGE ADJUSTING FUNCTION (FLOAT)
- COIN ACCEPT/INHIBIT FUNCTION
- OPTIONAL SATELLITE TUBES
- CURRENCY SELECTION (U.S. ONLY, CANADIAN ONLY, OR U.S. & CANADIAN).
- DATA STORED FUNCTION

INSTALLATION

1. Turn power off from vendor before installing the coin changer.
2. Remove the discriminator, push up on the discriminator latch and tilt the discriminator forward. (See Figure 3)
3. Align the coin changer key holes over the studs or screws in the vendor and tighten. (DO NOT OVER TIGHTEN!)
4. Set Currency Selection Switch on rear of discriminator to desired position and reinstall in changer housing (See Figure 5).
5. Connect the coin changer to the vendor and turn on the power.
6. Operate the reject lever to ensure proper alignment.

SETUP PROCEDURE

LOADING THE COIN CASSETTE (there are several options):

1. Through the Discriminator (See Figure 6): place the vendor controller into the "Tube Filling Mode". Inserted coins will be routed to the primary tubes and the coin count will be updated. When the upper tube sensor level is reached, the inserted coins will be routed to the cash box. NOTE: Depending on which cassette is used you may have to load one or two tubes manually. Before you remove the cassette to load these tubes, turn power "OFF" to the changer. Failure to follow these procedures will affect the coin count.
2. Manually From the Front (See Figure 7): we recommend that you fill each tube to the upper tube sensor or at least fill the primary tubes.
3. Manually by Removing the Cassette (See Figure 8): press down on the tube latch and remove the cassette assembly towards you. Squeeze the upper two levers to release the rear tube cover. Replenish as many individual coins into the respective tubes as required. Close the rear tube cover and reinstall the cassette assembly into place. We recommend you fill each tube to the upper tube sensor or at least fill the primary tubes.

NOTE: When you hand load tubes, the count reported to the controller is not exact, but will offer the maximum change available.